

**M23 FEMALE 0° 17POLE**

PUR (3x(2x0,14D)+2x0,5+4x0.14+4x0,22)C 7m

Signal cable for SINAMICS S120 and motors with connection M23

Female straight

M23, 17-pole

shielded

Further cable lengths on request.

Plastic housings with good resistance against chemicals and oils.

The resistance to aggressive media should be individually tested for your application. Further details on request.

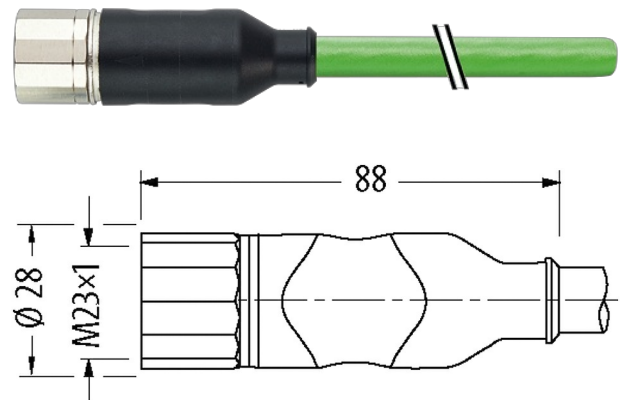
**[Link to Product](#)****Illustration**

Product may differ from Image

**Form**

Form SS521

**General data**

Temperature range -25...+85 °C, depending on cable quality

**Cables**

Cable number 811

No./diameter of wires 3 × (2×0.14D) + 2× 0.5 + 4× 0.14 + 4× 0.22)-C

Wire isolation PP (ye, gn, bk, br, rd, or, brrd brbl, gr, bl, whye, whbk, brye, brgr, gnbk, gnrd)

C-track properties 10 Mio.

Jacket Color green

Material (jacket) PUR (UL/CSA)

Outer Ø 9.5 mm ±5%

Bend radius (moving) 12× outer Ø

Temperature range (fixed) -50...+80 °C

Temperature range (mobile) -20...+60 °C

Shield yes

Bend radius (fixed) 10× outer Ø

Approval (cable) UL (AWM-Style 20236/1589), CSA; CE

**Technical Data**

Operating voltage max. 30 V AC/DC

Locking of ports Screw thread (M23×1 mm) recommended torque 2.0 Nm, self-securing

Protection IP67

**Commercial data**

country of origin DE

customs tariff number 85444290

EAN 4048879486446

eClass 27279218

Packaging unit 1

**Sketch**

Female

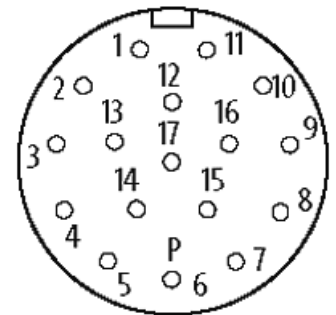

Product may differ from Image